

## MICROMETERS

All micrometers, unless otherwise indicated, are supplied with:

- Satin-Chrome Finish Sleeve and Thimble
- Fitted Case
- Appropriate Standards

## OUTSIDE MICROMETERS AND MICROMETER SETS



SERIES 196:



MEDA micrometers from 0-1 through 3-4 have forged steel frames and plastic insulating plates; micrometers from 4-5 through 11-12 have lightweight enamel frames.

- Carbide tipped measuring faces.
- Locknut
- Ratchet Stop

INCH Grad. .0001"		
Range	Order No.	Price
0-1"	4753010	
1-2	4753020	
2-3	4753030	
3-4	4753040	
4-5	4753050	
5-6	4753060	
6-7	4753070	
7-8	4753080	
8-9	4753090	
9-10	4753100	
10-11	4753110	
11-12	4753120	

METRIC Grad. .01mm		
Range (mm)	Order No.	Price
0-25	1960025	
25-50	1962550	
50-75	1965075	
75-100	1967510	
100-125	1961012	
125-150	1961215	
150-175	1961517	
175-200	1961720	
200-225	1962022	
225-250	1962225	
250-275	1962527	
275-300	1962730	

SETS of above micrometers in fitted cases.



### INCH SETS

Range	Grad.	Order No.	Price
0-3"	.0001"	4750401	
0-6	.0001"	4750402	
6-12	.0001"	4750403	
0-12	.0001"	4750404	

### METRIC SETS

Range	Grad.	Order No.	Price
0-75	.01mm	1960075	
0-150	.01mm	1960150	
150-300	.01mm	1961530	
0-300	.01mm	1960300	

## OUTSIDE MICROMETERS

MIT SERIES 101:

Mitutoyo



MITUTOYO's Series 101 Micrometers are one of the basic and most popular of all micrometers because of their functional and balanced design.

### FEATURES

- Carbide-tipped anvil and spindle, micro-lapped for high degree of flatness and parallelism, greater accuracy and tool life.
- Deep U-throat design for greater work clearance.
- Ratchet Stop or Friction Thimble for consistent repetitive measuring pressure.
- Positive and wear-adjustable spindle lock.
- Standard Bar furnished for micrometers with ranges 2" (50mm) and more.
- Supplied with fitted carrying case.
- Satin-chrome finish throughout.
- Fraction to decimal table on frame (.0001" reading micrometers up to 2" range only).

### INCH

Range	Order No.	Grad.	Type	Price
0-1	101105	.001"	Ratchet Stop	
0-1	101109	.001"	Friction Thimble	
0-1	101113	.0001"	Ratchet Stop	
0-1	101117	.0001"	Friction Thimble	
1-2	101106	.001"	Ratchet Stop*	
1-2	101110	.001"	Friction Thimble*	
1-2	101114	.0001"	Ratchet Stop*	
1-2	101118	.0001"	Friction Thimble*	
2-3	101119	.0001"	Ratchet Stop*	
3-4	101120	.0001"	Ratchet Stop*	

\*With Standard

## OUTSIDE MICROMETERS

MIT SERIES 102:

Mitutoyo



102 Series Micrometers are the deluxe version of the 101 Series. A pair of black heat insulating grip plates are attached on the frame. The micrometer comes with a friction thimble or ratchet stop to assure consistent measuring pressure, and reduce discrepancies in final readings from one inspector to another. The friction thimble has a speeder to quickly open and close the spindle.

**NOTE:** 102 Series inch models are featured with fraction to decimal equivalent tables. Metric models have no engravings on the heat-insulating grip plates.

### INCH

Range	Order No.	Price	Grad.	Type
0-1	102327		.0001"	Ratchet
1-2	102328		.0001"	Ratchet w/Standard

### METRIC

Range	Order No.	Price	Grad.	Type
0-25mm	102307		0.001mm	Ratchet
25-50mm	102308		0.001mm	Ratchet w/Standard

## 0-1" AND 0-25mm OUTSIDE MICROMETER CALIPERS

STARRETT SERIES 230:



English & Metric

With Lock Nut and carbide measuring faces. Satin chrome finish - no glare, balanced designed. Mirror lapped finish on anvil and spindle faces. One-piece extra rigid spindle. Hardened threads - ground from the solid. Rigid one piece frame - drop forged steel. Quick reading figures - every thousandth numbered (English reading models). R = Ratchet Stop F = Friction Thimble

Catalog No.	EDP No.	Range	Graduation	Price
T230XRL	50944	0-1"	.0001"	
T230XFL	50947	0-1"	.0001"	
V230MXRL	56017	0-25mm	0.001mm	
V230MXFL	56016	0-25mm	0.001mm	
910	55397	Case only		

Sent without case unless otherwise ordered.

## PROTECTIVE CASES FOR OUTSIDE MICROMETERS



Catalog No.	EDP No.	Description	Price
910	55397	1"/ 25mm	
913	55400	2"/ 50mm	
436ZZ-3	55222	3"/ 75mm	
436ZZ-4	55223	4"/ 100mm	
436ZZ-5	55224	5"/ 125mm	
436ZZ-6	55225	6"/ 150mm	
436ZZ-7	55276	7"/ 175mm	
436ZZ-8	55277	8"/ 200mm	
436ZZ-9	55278	9"/ 225mm	
436ZZ-10	55279	10"/ 250mm	
436ZZ-11	55280	11"/ 275mm	
436ZZ-12	55281	12"/ 300mm	

## MICROMETER STAND

SERIES 345:



**PANA VISE**

- Delrin® contact pads firmly hold your micrometer.
- Knob adjustment controls the holding pressure.
- Sturdy die-cast aluminum head with 5/8" diameter post.
- Base permits 90° tilt, 360° turn and 360° rotation
- Base has three 1/4" countersunk holes on a 4-5/16" bolt circle for easy attachment to work benches.



Order No. 3450391
Price

364

Starrett



## OUTSIDE MICROMETERS (0-6", 0-150mm RANGE)

STARRETT SERIES 436:

Starrett



Precision performance combined with strength, rigidity, lightness and moderate price. Forged frames, ribbed for extra strength, have black enamel finish and are tapered for use in narrow slots and tight places. Good balance, easy handling. Satin chrome finish on sleeve and thimble. Staggered lines and distinct figures on sleeve. Quick-reading figures on thimble with every thousandth numbered. Micro-lapped finish on anvil and spindle faces. One-piece hardened spindle with threads ground from the solid and stabilized. Convenient decimal equivalents on the thimble. 1 - 6" & 25 - 150mm models sent in fitted plastic case.

### INCH

Range	Grad.	Description	Catalog No.	EDP No.	Price
0 - 1"	.001"	Plain	436.1P-1	67990	
0 - 1	.001		436.1RL-1	67993	
1 - 2	.001	With ratchet stop, lock nut	436.1RL-2	9968002	
2 - 3	.001		436.1RL-3	9968010	
3 - 4	.001		436.1RL-4	9968017	
5 - 6	.001		436.1RL-5	68023	
5 - 6	.001		436.1RL-6	68029	

### CARBIDE MEASURING FACES AND LOCK NUT

Range	Grad.	Description	Catalog No.	EDP No.	Price
0 - 1"	.0001"	R = With Ratchet Stop	T436.1XRL-1	67997	
1 - 2	.0001		T436.1XFL-1	67999	
2 - 3	.0001	F = With Friction Thimble	T436.1XRL-2	968005	
			T436.1XFL-2	968007	
T436.1XRL-3	68013				
T436.1XFL-3	968015				
3 - 4	.0001		T436.1XRL-4	68019	
4 - 5	.0001		T436.1XFL-4	68021	
		T436.1XRL-5	68025		
5 - 6	.0001	T436.1XFL-5	68027		
		T436.1XRL-6	68031		
5 - 6	.0001	T436.1XFL-6	68033		

### METRIC

Range mm	Description	Grad.	Catalog No.	EDP No.	Price
0-25	Friction Thimble, Lock Nut, Carbide Faces	0.01mm	436.1MXFL-25	68050	
25-50	Ratchet Stop, Lock Nut, Carbide Faces	0.01mm	436.1MXRL-50	68053	
25-50		0.001mm	V436.1MXRL-50	68054	
50-75	Ratchet Stop, Lock Nut, Carbide Faces	0.01mm	436.1MXRL-75	68056	
50-75		0.001mm	V436.1MXRL-75	968057	
75-100	Ratchet Stop, Lock Nut, Carbide Faces	0.01mm	436.1MXRL-100	68059	
75-100		0.001mm	V436.1MXRL-100	968060	
100-125	Ratchet Stop, Lock Nut, Carbide Faces	0.01mm	436.1MXRL-125	68062	
100-125		0.001mm	V436.1MXRL-125	68063	
125-150	Ratchet Stop, Lock Nut, Carbide Faces	0.01mm	436M.1XRL-150	68065	
125-150		0.001mm	V436.1MXRL150	68066	

## MICROMETER WITH INSULATED FRAME

STARRETT SERIES 231:



Starrett



Range: 0-1", Graduation: .0001"

- Slightly heavier micrometer with thermal insulators mounted on the frame front and rear.
- Quick-reading features – every thousandth numbered.
- Ring-type knurled lock nut for quick and sure locking.
- Combination ratchet and speeder.
- Carbide measuring faces.

Catalog No.	EDP No.	Price
T231XRL	63967	

## 0-24", 0-600mm OUTSIDE MICROMETER CALIPERS SETS

STARRETT SERIES 436:



Starrett



Recommended for mechanics, automotive service and machine shops, tool rooms, inspection departments and wherever gaging involves a wide range of measurements. All sets come in an attractive, protective case which keeps micrometers and standards together readily accessible.

Ratchet stop except where noted (\*).

Catalog No.	EDP No.	Range	Graduation	Price
<b>WITH LOCKNUT, RATCHET STOP*, CARBIDE FACES</b>				
ST436.1AXRLZ	68037	0-3"	.0001"	
ST436.1AXFLZ*	68038	0-3"	.0001"	
S436.1MAXRLZ	68068	0-75mm	0.01mm	
SV436.1MAXRLZ	68069	0-75mm	0.001mm	
ST436.1BXRLZ	68041	0-4"	.0001"	
S436.1MBXRLZ	68071	0-100mm	0.01mm	
SV436.1MBXRLZ	68072	0-100mm	0.001mm	
ST436.1CXRLZ	68045	0-6"	.0001"	
ST436.1CXFLZ*	68046	0-6"	.0001"	
S436.1MCXRLZ	68074	0-150mm	0.01mm	
SV436.1MCXRLZ	968075	0-150mm	0.001mm	
ST436.1DXRLZ	64465	6-12"	.0001"	
S436.1MDXRLZ	64461	150-300mm	0.01mm	
ST436.1EXRLZ	52030	0-12"	.0001"	
S436.1MEXRLZ	52014	0-300mm	0.01mm	
S436.1FXRLZ	64466	12-24"	.001"	
S436.1MFXRLZ	64462	300-600mm	0.01mm	

## OUTSIDE MICROMETERS (7-12", 150-300mm RANGE)

STARRETT SERIES 436:



Starrett



Micrometers have no-glare satin chrome finish on sleeves and thimbles and black wrinkled finish on frames which are perforated for lightness. Thimbles are large, well balanced, and have quick-reading figures with every thousandth numbered. .300" Diameter anvils and spindles have micro-lapped measuring faces. One piece spindles are hardened with threads ground from the solid and stabilized.

Range	Grad.	Description	Catalog No.	EDP No.	Price
6 - 7"	.001"	With ratchet stop, lock nut	436RL-7	51684	
7 - 8	.001	With ratchet stop, lock nut	436RL-8	51712	
8 - 9	.001	With ratchet stop, lock nut	436RL-9	51740	
9 - 10	.001	With ratchet stop, lock nut	436RL-10	51768	
10 - 11	.001	With ratchet stop, lock nut	436RL-11	51796	
11 - 12	.001	With ratchet stop, lock nut	436RL-12	51824	



Starrett

Outside Micrometers 13-24" available; please inquire.

Range mm	Description	Grad.	Catalog No.	EDP No.	Price
150-175		0.01mm	436MXRL-175	51706	
175-200		0.01mm	436MXRL-200	51734	
200-225	Ratchet Stop,	0.01mm	436MXRL-225	51762	
225-250	Lock Nut,	0.01mm	436MXRL-250	51790	
250-275	Carbide Faces	0.01mm	436MXRL-275	51818	
275-300		0.01mm	436MXRL-300	51846	

Starrett

Outside Micrometers 325 - 600mm available; please inquire.



Quality Precision Tools

MEGA Superior Import

Mitutoyo Starrett

The Choice Is Yours!!!

## OUTSIDE MICROMETERS Mitutoyo

MIT SERIES 103:



103126

- Carbide faces.
- Positive locking clamp.
- Friction Thimble or Ratchet Stop for exact repetitive readings.
- Hammertone-green, baked enamel finished frame.
- Clear graduations on satin-chrome finish.
- Complete with fitted carrying case.

INCH				
Range	Order No.	Price	Graduation	Type
0-1	103127		.001	Friction
0-1	103259		.001	Ratchet
0-1	103135		.0001	Friction
1-2	103128		.001	Friction w/Standard
1-2	103136		.0001	Friction w/Standard
METRIC				
0-25mm	103125		0.01mm	Friction
0-25mm	103133		0.001mm	Friction
25-50mm	103126		0.01mm	Friction w/Standard
25-50mm	103134		0.001mm	Friction w/Standard

PRECISION TOOLS

## OUTSIDE MICROMETERS Mitutoyo

MIT SERIES 103:

### RATCHET STOP TYPE

Among the many series listed in this catalog, the 103 Series is the workhorse of the micrometers. Up to 12" or 300mm, 103 Series micrometers are automatically supplied with a standard bar.



While we show the most popular MITUTOYO items, we can supply their entire range of products; please inquire.



103177



103260

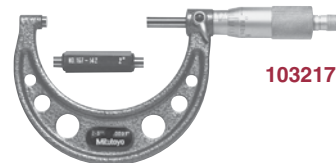

103217

INCH Graduation .001"		
Range	Order No.	Price
0-1	103177	
1-2	103178	
2-3	103179	
3-4	103180	
4-5	103181	
5-6	103182	
6-7	103183	
7-8	103184	
8-9	103185	
9-10	103186	
10-11	103187	
11-12	103188	

INCH Graduation .0001"		
Range	Order No.	Price
0-1	103260	
1-2	103262	
2-3	103217	
3-4	103218	
4-5	103219	
5-6	103220	
6-7	103221	
7-8	103222	
8-9	103223	
9-10	103224	
10-11	103225	
11-12	103226	

METRIC Graduation .01mm		
Range	Order No.	Price
0-25mm	103137	
25-50mm	103138	
50-75mm	103139	
75-100mm	103140	
100-125mm	103141	
125-150mm	103142	
150-175mm	103143	
175-200mm	103144	
200-225mm	103145	
225-250mm	103146	
250-275mm	103147	
275-300mm	103148	

## LARGE OUTSIDE MICROMETERS (INCH)

Supplied with fitted case, but without standard.

Graduation .001"

Range	Order No.	Price	Range	Order No.	Price	Range	Order No.	Price	Range	Order No.	Price
12-13	103189		19-20	103196		26-27*	103203		33-34	103210	
13-14	103190		20-21	103197		27-28*	103204		34-35	103211	
14-15	103191		21-22	103198		28-29	103205		35-36*	103212	
15-16	103192		22-23	103199		29-30*	103206		36-37*	103213	
16-17	103193		23-24	103200		30-31	103207		37-38*	103214	
17-18	103194		24-25	103201		31-32*	103208		38-39*	103215	
18-19	103195		25-26	103202		32-33*	103209		39-40	103216	

\*Includes standard.

**MICROMETER SETS** *Mitutoyo*

MIT SERIES 103:

Micrometer sets are supplied with all necessary standards and wrenches in a double-latched, foam padded wooden case.

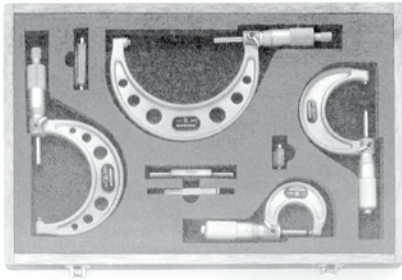

**INCH SETS .001" GRADUATION INDIVIDUAL MICROMETERS**

Range	Order No.	Price	Range	Order No.	Price	Range	Order No.	Price
0-12" Set (with 11 Standards)	103905		0-3" Set (with 2 Standards)	103929		0-1	103177	
						1-2	103178	
						2-3	103179	
0-12" Set (with 11 Standards)	103905		0-6" Set (with 5 Standards)	103904		0-1	101105	
						1-2	101106	
						2-3	103179	
			6-12" Set (with 6 Standards)	103906		3-4	103180	
						4-5	103181	
						5-6	103182	
			6-7	103183				
			7-8	103184				
			8-9	103185				
			9-10	103186				
			10-11	103187				
			11-12	103188				

**INCH SETS .0001" GRADUATION INDIVIDUAL MICROMETERS**

Range	Order No.	Price	Range	Order No.	Price	Range	Order No.	Price
0-12" Set (with 11 Standards)	103908		0-3" Set (with 2 Standards)	103922		0-1	103135	
						1-2	103136	
						2-3	103217	
0-12" Set (with 11 Standards)	103908		0-6" Set (with 5 Standards)	103907		0-1	103135	
						1-2	103136	
						2-3	103217	
			6-12" Set (with 6 Standards)	103909		3-4	103218	
						4-5	103219	
						5-6	103220	
			6-7	103221				
			7-8	103222				
			8-9	103223				
			9-10	103224				
			10-11	103225				
			11-12	103226				



**METRIC SETS 0.01mm GRADUATION INDIVIDUAL MICROMETERS**

Range	Order No.	Price	Range	Order No.	Price	Range	Order No.	Price
0-300mm SET (with 11 Standards)	103914		0-75mm Set (with 2 Standards)	103927		0-25mm	103137	
						25-50mm	103138	
						50-75mm	103139	
0-300mm SET (with 11 Standards)	103914		0-150mm Set (with 5 Standards)	103913		0-25mm	103137	
						25-50mm	103138	
						50-75mm	103139	
			150-300mm Set (with 6 Standards)	103915		75-100mm	103140	
						100-125mm	103141	
						125-150mm	103142	
			150-175mm	103143				
			175-200mm	103144				
			200-225mm	103145				
			225-250mm	103146				
			250-275mm	103147				
			275-300mm	103148				

**DIGITAL OUTSIDE MICROMETERS**



SERIES 199:

The digital counter indicates direct reading in 1/1000; "tenths" are read by means of a clearly marked vernier scale.

- Carbide tipped measuring faces.
- Locknut
- Ratchet Stop



**INCH**

Range	Grad.	Order No.	Price
0-1	.0001	1450601	
1-2	.0001	1450602	
2-3	.0001	1450603	
3-4	.0001	1450604	

Set of above in fitted case.

0-3	.0001	1450649	
-----	-------	---------	--

## DIGITAL OUTSIDE MICROMETERS

STARRETT SERIES 216:



Digital micrometers make readings faster and easier. Thousandths of an inch are read directly from a counter. Ten-thousandths of an inch are taken from a quick-reading vernier scale on the micrometer sleeve. The frame-mounted counter saves considerable handling time since its numbers can be read without removing fingers from thimble or micrometer from hand.

Available with ratchet stop or friction thimble to assure repeat accuracy of readings and with lock nut to secure the spindle at any reading. Micro-lapped anvil and spindle faces. Carbide measuring faces. Hardened threads ground from the solid and stabilized. Balanced design throughout with rugged one-piece frame of drop-forged steel to assure stability. Micrometers have no-glare black finish frame with satin chrome finish on thimble and sleeve. Case must be ordered separately

- .001" or .01 mm is read directly from the counter.
- .0001" or .001 mm is read from the vernier scale on the micrometer sleeve.

### RATCHET STOP

Range	Catalog No.	EDP No.	Price
<b>Graduation .001"</b>			
0 - 1"	T216XRL-1	55955	
<b>Graduation .0001"</b>			
0 - 1"	T216XRL-1	55959	
1 - 2"	T216XRL-2	56156	
2 - 3"	T216XRL-3	63491	
3 - 4"	T216XRL-4	63492	
4 - 5"	T216XRL-5	63493	
5 - 6"	T216XRL-6	63494	
<b>Graduation 0.01mm</b>			
0-25mm	216MXRL-25	55983	
25-50mm	216MXRL-50	65602	
50-75mm	216MXRL-75	65603	
75-100mm	216MXRL-100	65604	
100-125mm	216MXRL-125	64351	
125-150mm	216MXRL-150	9964352	
<b>Graduation 0.001mm</b>			
0-25mm	V216MXRL-25	56037	
25-50mm	V216MXRL-50	64348	
50-75mm	V216MXRL-75	64349	
75-100mm	V216MXRL-100	64350	

### FRICTION THIMBLE

Range	Catalog No.	EDP No.	Price
<b>Graduation .001"</b>			
0 - 1"	216XFL-1	55956	
<b>Graduation .0001"</b>			
0 - 1"	T216XFL-1	55960	
1 - 2"	T216XFL-2	56157	
2 - 3"	T216XFL-3	63634	
3 - 4"	T216XFL-4	63635	
<b>Graduation 0.01mm</b>			
0-25mm	216MXFL-25	55984	
<b>Graduation 0.001mm</b>			
0-25mm	V216MXFL-25	56036	

Digital micrometers 6-12" and 175-300mm available; please inquire.



## DIGIT-OUTSIDE MICROMETERS Mitutoyo

MIT SERIES 193:

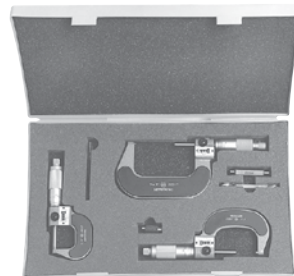

### FEATURES:

- Mechanical counter for quick and error-free reading.
  - Direct readout on the counter to .001"/0.01mm.
  - Carbide-tipped measuring faces.
  - Supplied with all necessary standards.
- Although conventional thimble and sleeve may not be read frequently, they are incorporated in this series to verify the digital counter's readings and to indicate accuracy.

### INCH Friction Thimble

Range	Order No.	Graduation	Price
0-1	193201	.001	
0-1	193211	.0001	

### INCH Ratchet Stop

Range	Order No.	Graduation	Price
1-2	193212	.0001	
2-3	193213	.0001	
3-4	193214	.0001	
4-5	193415	.0001	
5-6	193416	.0001	
6-7	193417	.0001	
7-8	193418	.0001	
8-9	193419	.0001	
9-10	193420	.0001	
10-11	193421	.0001	

### DIGIT MICROMETER SETS - INCH (in fitted case)

Range	Order No.	Graduation	Price
0-3	193923	.0001	
0-6	193930	.0001	

### METRIC Ratchet Stop

Range	Order No.	Graduation	Price
0-25mm	193101	0.01mm	
0-25mm	193111	0.001mm	
25-50mm	193102	0.01mm	
25-50mm	193112	0.001mm	
50-75mm	193103	0.01mm	
50-75mm	193113	0.001mm	
75-100mm	193104	0.01mm	
75-100mm	193114	0.001mm	
100-125mm	193305	0.01mm	
125-150mm	193306	0.01mm	
150-175mm	193307	0.01mm	
175-200mm	193308	0.01mm	
200-225mm	193309	0.01mm	
225-250mm	193310	0.01mm	

### DIGIT MICROMETER SETS - METRIC (in fitted case)

Range	Order No.	Graduation	Price
0-75mm	193901	0.01mm	
0-75mm	193915	0.001mm	
0-150mm	193908	0.01mm	

**ELECTRONIC MICROMETERS**

STARRETT SERIES 795:  
STARRETT SERIES 796:



Starrett 795 and 796 Electronic Micrometers provide an IP67 level of protection against coolant, water, chips, dirt, dust, and other contaminants in hostile shop environments.

The 795 includes an RS232 output port for data transmission and works well with Starrett DataSure® Wireless Data Collection Systems. The 796 has all of the features of the 795 except it does not include output.

**Features and Specifications**

- Large, easy-to-read (.275"/7mm), high-contrast LCD digital readout
- Smooth friction thimble for uniform pressure
- Two 3-volt batteries included for more than one year of normal usage
- Micro-lapped carbide measuring faces
- Automatic OFF after 20 minutes of nonuse
- Instant inch/millimeter conversion
- Measurement HOLD button
- Ability to zero tool at any position as well as retain and return to the true zero reading of the micrometer
- Resolution: .00005" (0.001mm)
- Accuracies: Inch: ±.0001"  
Metric: ±.002mm

Range	Description	Catalog No.	EDP No.	Price
0-1"/0-25mm	Friction Thimble, spindle lock, carbide faces, shell & thimble inch grads., with output & case	795XFL-1	67827	
0-1"/0-25mm	Ratchet stop, lock nut, carbide faces, shell & thimble inch grads., with output & case	795XRL-1	69085	
0-25mm"/0-.984"	Friction Thimble, spindle lock, carbide faces, shell & thimble metric grads., with output & case	795MEXFL-25	69077	
0-1"/0-25mm	Friction Thimble, spindle lock, carbide faces, shell & thimble inch grads., with case, no output	796XFL-1	67828	
0-1"/0-25mm	Ratchet stop, lock nut, carbide faces, shell & thimble inch grads. with case, no output	796XRL-1	69089	
0-25mm	Friction Thimble, spindle lock, carbide faces, shell & thimble metric grads., with case, no output	796MXFL-25	69084	



**DIGITAL ELECTRONIC OUTSIDE MICROMETERS**



SERIES 725:

- 5 keys Positive-designed electronic micrometer
- Large and clear LCD.
- Absolute and incremental conversion.
- Friction thimble.
- Data hold and Tolerance set.
- SPC output



Range	Graduation	Order No.	Price
0-1"/0-25mm	.00005"/.001mm	7250001	
1-2"/25-50mm	.00005"/.001mm	7250012	
2-3"/50-75mm	.00005"/.001mm	7250023	

**ELECTRONIC DIGITAL OUTSIDE MICROMETER (WITHOUT OUTPUT)**



STARRETT SERIES 3732:

This tool is a basic electronic micrometer. It has no output but has all the ease of handling and accuracy features of No. 733 full function micrometer (see next page).



Accuracy: ±.0001", ±0.002mm

- Instant inch/millimeter conversion.
- ON/OFF button (auto off after 30 minutes of non-use).
- Ability to zero tool at any position as well as retain and return to the true zero reading of the micrometer
- Large, high-contrast LCD readout.
- Balanced frame and smooth friction thimble with satin chrome finish.
- Extremely hard, stable, one-piece spindle for superb accuracy.
- Micro-lapped carbide measuring faces.
- Ring-type knurled locking mechanism.
- Includes fitted plastic case.

Catalog No.	EDP No.	Resolution		Range		Price	
		Inch	mm	Inches	mm		
3732XFL-1	912268	.00005	0.001	0-1	0-25		
PT99492	65650	One 3-Volt Battery No. CR2032					

**MDC-LITE DIGITAL MICROMETER - WITHOUT SPC OUTPUT**

MIT SERIES 293:

**FEATURES**

- Inch/Metric Key
- The world's lightest digital micrometer.
- Made slim for easy access to stepped feature.
- Measuring Range through 1"/25.4mm with resolution to .00005"/0.001mm
- Accuracy ±.0001/ ±.2µm • Measuring faces carbide tipped.
- Includes a zero-set key for easy origin setting.
- A ratchet stop or friction thimble for a constant measuring force.
- Measurement readout with large characters on the LCD screen.
- The display stays on for the entire battery life (approx. 1.2 years).
- Battery: SR44 (1pc.) (Part No. 541980).
- No spindle clamp, no data output.



Ratchet Stop



Friction Thimble

MDC-Lite is an economy version Digimatic Micrometer with a slimmer design and lighter weight than other models. It reduces operator fatigue, and measures in areas other micrometers can't touch.

Order No.	Remarks	Price
293831	Ratchet Stop	
293832	Friction Thimble	



## ELECTRONIC DIGITAL OUTSIDE MICROMETERS - WITH OUTPUT

STARRETT SERIES 733:



This is the new Starrett No. 733 full function electronic digital outside micrometer with all the features and controls you need to measure, analyze and record the information you want. The anvil and spindle diameter is .250" (6.35mm). Micrometers are furnished in protective cases except for the 25mm model. Standards not furnished and must be ordered separately.

### READABILITY FEATURES

- Large, right-sized, high-contrast LCD digital readout is easy to read and reduces errors
- Conventional inch or millimeter graduations standard
- Attractive no-glare black wrinkle finish on the frame
- Starrett no-glare satin chrome finish on thimble and sleeve

### EASE-OF-HANDLING, ACCURACY AND LONG-LIFE FEATURES

- Balanced frame design for comfortable and accurate measuring
- Ring-type knurled lock nut for quick and sure locking
- Smooth friction thimble for uniform pressure
- Gracefully designed tapered frame for use in narrow slots and tight places
- ±.0001" or ±0.002mm Accuracy
- Extremely hard and stable one-piece spindle
- Micro-lapped carbide measuring faces
- Starrett designed electronic microprocessor
- One battery for dependable power and over one year's normal usage
- Automatic OFF after 30 minutes of nonuse

### FULL-FUNCTION ACTION FEATURES

- Easiest keyboard control by use of the new SHIFT button
- Instant inch/millimeter conversion.
- "ME" Millimeter Models turn on in millimeter mode after installation of new battery.
- Measurement HOLD button
- Ability to zero tool at any position
- Ability to retain and return to the true zero reading of the micrometer
- PRESET button to install any reading at any position
- Ability to install minimum and maximum limits, except on straight metric models
- Output jack allows data transmission to the following peripherals for analysis, data collection and hard copy documentation:

Starrett 772 Series Advanced Data Collection Systems  
 Starrett 761 Series Data Multiplexers  
 Other devices that support RS232-C



While we show the most popular Starrett items, we can supply their entire range of products; please inquire.

With standard inch graduations on shell and thimble.

Range	Resolution	Catalog No.	EDP No.	Price
0-1"/0-25mm	.00005"/0.001mm	733XFL-1	64239	
1-2"/25-50mm	.00005"/0.001mm	733XFLZ-2	64241	
2-3"/50-75mm	.00005"/0.001mm	733XFLZ-3	64242	
3-4"/75-100mm	.00005"/0.001mm	733XFLZ-4	64243	
4-5"/100-125mm	.0001"/0.001mm	733XFLZ-5	64244	
5-6"/125-150mm	.0001"/0.001mm	733XFLZ-6	64245	
6-7"/150-175mm	.0001"/0.001mm	733XFLZ-7	64246	
7-8"/175-200mm	.0001"/0.001mm	733XFLZ-8	64247	
8-9"/200-225mm	.0001"/0.001mm	733XFLZ-9	64248	
9-10"/225-250mm	.0001"/0.001mm	733XFLZ-10	64249	
10-11"/250-275mm	.0001"/0.001mm	733XFLZ-11	64250	
11-12"/275-300mm	.0001"/0.001mm	733XFLZ-12	64251	
12-13"/300-325mm	.0001"/0.001mm	733XFLZ-13	64415	
13-14"/325-350mm	.0001"/0.001mm	733XFLZ-14	64416	
14-15"/350-375mm	.0001"/0.001mm	733XFLZ-15	64417	
15-16"/375-400mm	.0001"/0.001mm	733XFLZ-16	64418	
16-17"/400-425mm	.0001"/0.001mm	733XFLZ-17	64419	
17-18"/425-450mm	.0001"/0.001mm	733XFLZ-18	64420	
18-19"/450-475mm	.0001"/0.001mm	733XFLZ-19	64421	
19-20"/475-500mm	.0001"/0.001mm	733XFLZ-20	64422	
20-21"/500-525mm	.0001"/0.001mm	733XFLZ-21	64423	
21-22"/525-550mm	.0001"/0.001mm	733XFLZ-22	64424	
22-23"/550-575mm	.0001"/0.001mm	733XFLZ-23	64425	
23-24"/575-600mm	.0001"/0.001mm	733XFLZ-24	64426	

With standard millimeter graduations on shell and thimble.

Range	Resolution	Catalog No.	EDP No.	Price
0-25mm	0.001mm/.0001"	733MEXFL-25	65440	
25-50mm	0.001mm/.0001"	733MEXFLZ-50	65441	
50-75mm	0.001mm/.0001"	733MEXFLZ-75	66079	
75-100mm	0.001mm/.0001"	733MEXFLZ-100	66080	
100-125mm	0.001mm/.0001"	733MEXFLZ-125	66081	
125-150mm	0.001mm/.0001"	733MEXFLZ-150	66082	
150-175mm	0.001mm/.0001"	733MEXFLZ-175	66083	
175-200mm	0.001mm/.0001"	733MEXFLZ-200	66084	
200-225mm	0.001mm/.0001"	733MEXFLZ-225	66085	
225-250mm	0.001mm/.0001"	733MEXFLZ-250	66086	
250-275mm	0.001mm/.0001"	733MEXFLZ-275	66087	
275-300mm	0.001mm/.0001"	733MEXFLZ-300	66088	
300-325mm	0.001mm/.0001"	733MEXFLZ-325	66089	
325-350mm	0.001mm/.0001"	733MEXFLZ-350	66090	
350-375mm	0.001mm/.0001"	733MEXFLZ-375	66091	
375-400mm	0.001mm/.0001"	733MEXFLZ-400	66092	
400-425mm	0.001mm/.0001"	733MEXFLZ-425	66093	
425-450mm	0.001mm/.0001"	733MEXFLZ-450	66094	
450-475mm	0.001mm/.0001"	733MEXFLZ-475	66095	
475-500mm	0.001mm/.0001"	733MEXFLZ-500	66096	
500-525mm	0.001mm/.0001"	733MEXFLZ-525	66097	
525-550mm	0.001mm/.0001"	733MEXFLZ-550	66098	
550-575mm	0.001mm/.0001"	733M3XFLZ-575	66099	
575-600mm	0.001mm/.0001"	733MEXFLZ-600	66100	

### Accessories/Parts

Description	Catalog No.	EDP No.	Price
0-25mm Deluxe Padded Case	949	63874	
Adapter from No. PT22938	PT61768	66454	
Cable to IBM-PC (RS232C)			
Shielded Cable to Nos. 761/772 Series Starrett Modules, No. 768 Remote Display, No. PT61768 Adapter	PT22938	64059	
One 3-volt Battery No. CR2450	PT61120	65446	
Computer Interface Cable complete to IBM-PC (RS232C)	PT61963	66636	



## QUICKMIKE WITH ABSOLUTE ENCODER

MIT SERIES 293:

The Quickmike is a revolution in digital micrometer technology from Mitutoyo the world leader in precision measuring instruments and tools. Because of its extraordinary features the Quickmike allows high accuracy measurements to be performed even by unskilled operators in drastically reduced inspection time.

### FEATURES:

- Quick non-rotating 1.2" (30mm) stroke spindle... the spindle advances .4" (10mm) per thimble rotation- no-torsion on the workpiece, reducing inspection time.
- Absolute Encoder... set the origin only once! The absolute linear scale tracks the origin throughout the life of battery, meaning no more zero setting, pre-setting or overspeed errors.
- IP-54 protection... resist water splash & shop floor contaminants for safe operation in harsh machine shop environments (when not connected with data output cable).
- Large LCD readout for easy reading.
- SPC data output.
- Fitted Case



### SPECIFICATIONS

Resolution: .00005"/0.001mm (.00012" or less on 293-679)

Measuring Faces: Carbide

### FUNCTIONS:

- Origin setting
- Data Hold
- Inch/Metric Conversion
- SPC output
- Low battery voltage alarm.
- Scale contamination alarm.

Order No.	Range	Price
293-676	0-1.2"/0-30mm	
293-677	1-2.2"/25-55mm	
293-678	2-3.2"/50-80mm	
293-679	3-4.2"/75-105mm	

### STANDARD ACCESSORIES:

Silver oxide cell (SR-44) 1pc, necessary standard, fitted case

For SPC output order connecting cable 937387 (1m) or 965013(2m).

Replacement Battery: 541980 (1pc.), 541980-10(10pcs/SET).

## DIGIMATIC MICROMETERS

MIT SERIES 293:

### WITH SPC OUTPUT

#### INCH/METRIC

Order No.	Range	Resolution	Accuracy	Remarks	Price
293-330	0-1" 0-25.4mm	.00005" 0.001mm	±.00005	with SPC output Ratchet Stop, IP 65*	
293-331	1-2" 25.4-50.8mm	.00005" 0.001mm	±.00005	with SPC output and Standard Ratchet Stop, IP 65*	
293-332	2-3" 50.8-76.2mm	.00005" 0.001mm	±.00005	with SPC output and Standard Ratchet Stop, IP 65*	
293-333	3-4" 76.2-101.6mm	.00005" 0.001mm	±.0001	with SPC output and Standard Ratchet Stop, IP65*	
293-350-10	4-5" 101.6-127.0mm	.0001" 0.001mm	±.0001	with SPC output and Standard Ratchet Stop	
293-351-10	5-6" 127.0-152.4mm	.0001" 0.001mm	±.0001	with SPC output and Standard Ratchet Stop	
293-352-10	6-7" 152.4-177.8mm	.0001" 0.001mm	±.00015"	with SPC output and Standard Ratchet Stop	
293-353-10	7-8" 177.8-203.2mm	.0001" 0.001mm	±.00015	with SPC output and Standard Ratchet Stop	
293-354-10	8-9" 203.2-228.6mm	.0001" 0.001mm	±.00015	with SPC output and Standard Ratchet Stop	
293-355-10	9-10" 228.6-254.0mm	.0001" 0.001mm	±.0002	with SPC output and Standard Ratchet Stop	
293-356-10	10-11" 254.0-279.4mm	.0001" 0.001mm	±.0002	with SPC output and Standard Ratchet Stop	
293-357-10	11-12" 279.4-304.8mm	.0001" 0.001mm	±.0002"	with SPC output and Standard Ratchet Stop	
293-771	12-13" 304.8-330.2mm	.0001" 0.001mm	±.00025"	with SPC output and Standard Ratchet Stop	
293-772	13-14" 330.2-355.6mm	.0001" 0.001mm	±.00025"	with SPC output and Standard Ratchet Stop	
293-773	14-15" 355.6-381.0mm	.0001" 0.001mm	±.00025"	with SPC output and Standard Ratchet Stop	
293-774	15-16" 381.0-406.4mm	.0001" 0.001mm	±.0003"	with SPC output and Standard Ratchet Stop	
293-775	16-17" 406.4-431.8mm	.0001" 0.001mm	±.0003"	with SPC output and Standard Ratchet Stop	
293-776	17-18" 431.8-457.2mm	.0001" 0.001mm	±.0003"	with SPC output and Standard Ratchet Stop	
293-777	18-19" 457.2-482.6mm	.0001" 0.001mm	±.00035"	with SPC output and Standard Ratchet Stop	
293-778	19-20" 482.6-508.0mm	.0001" 0.001mm	±.00035	with SPC output and Standard Ratchet Stop	
293-335	0-1" 0-25.4mm	.00005" 0.001mm	±.00005"	with SPC output and Standard Friction Thimble, IP 65*	
293-336	1-2" 25.4-50.8mm	.00005" 0.001mm	±.00005"	with SPC output and Standard Friction Thimble, IP 65*	

New Ratchet-Friction Thimble



293-344



Ratchet Stop

293-340



293-771



Standard Friction Thimble  
293-348

### FEATURES

- Extra large LCD readout.
- Lightweight design and digital display allow measurements to be taken with the micrometer held in one hand.
- Two measuring modes-ABS (absolute) and INC (incremental)-for efficient measurement (with SPC output Model).
- Functions available: Origin setting, Inch/mm selection, Zero-setting, Data Hold only with SPC Models, Error alarm, Auto-sleep, Data output.
- Can be linked to the SPC system.
- Three types of constant-force devices are available: ratchet stop, ratchet-friction thimble, and friction thimble.
- Carbide-tipped measuring faces.
- Micrometers of ranges up to 4" (100mm) are "One-touch preset type", whereas those of ranges exceeding 4" (100mm) are "All-digit preset type".
- Origin setting function (ABS mode): The origin point value can be displayed with a touch of the ORIGIN button. (It is also possible to set any value as the origin.)
- Zero setting function (INC mode)

\*IP 65 Dust/Water Protection Level

(Continued)

## DIGIMATIC MICROMETERS (Continued)

MIT SERIES 293:

WITH AND WITHOUT SPC OUTPUT



**293-344**  
NEW RATCHET - FRICTION THIMBLE



**293-340**  
RATCHET STOP



**293-348**  
STANDARD FRICTION THIMBLE

### INCH/METRIC IP 65 Dust/Water Protection Level WITHOUT SPC OUTPUT

Order No.	Range	Resolution	Accuracy	Remarks	Price
293-340	0-1" 0-25.4mm	.00005" 0.001mm	±.00005"	Without SPC output Ratchet Stop	
293-341	1-2" 25.4-50.8mm	.00005" 0.001mm	±.00005"	Without SPC output Ratchet Stop	
293-342	2-3" 50.8-76.2mm	.00005" 0.001mm	±.00005"	Without SPC output Ratchet Stop	
293-343	3-4" 76.2-101.6mm	.0001" 0.001mm	±.00001"	Without SPC output Ratchet Stop	
293-344	0-1" 0-25.4mm	.00005" 0.001mm	±.00005"	Without SPC output Ratchet-Friction Thimble	
293-345	1-2" 25.4-50.8mm	.00005" 0.001mm	±.00005"	Without SPC output Ratchet-Friction Thimble	
293-346	2-3" 50.8-76.2mm	.00005" 0.001mm	±.00005"	Without SPC output Ratchet-Friction Thimble	
293-347	3-4" 76.2-101.6mm	.00005" 0.001mm	±.0001"	Without SPC output Ratchet-Friction Thimble	
9293-348	0-1" 0-25.4mm	.00005" 0.001mm	±.00005"	Without SPC output Friction Thimble	
293-349	0-1" 0-25.4mm	.0001" 0.001"	±.0001"	Without SPC output Ratchet-Friction Thimble	

### SETS INCH/METRIC \*IP 65 Dust/Water Protection Level WITH SPC OUTPUT

Order No.	Range	Resolution	Remarks	Price
293-960	0-3" (3 pcs set) 0-76.2mm	.00005" 0.001mm	With SPC output & Standards (3 pcs Micrometer SET) Ratchet Stop	
293-961	0-4" (4 pcs set) 0-25.4mm	.00005" 0.001"	With SPC output & Standards (4 pcs Micrometer SET) Rathchet Stop	

### Metric Only Reading (No Inch/mm function, metric thimble)

### WITHOUT SPC OUTPUT

Order No.	Range	Resolution	Accuracy	Remarks	Price
293-240	0-25mm	0.001mm	±.001mm	Without SPC output, Ratchet Stop	
293-241	25-50mm	0.001mm	±.001mm	Without SPC output, Ratchet Stop	
293-242	50-75mm	0.001mm	±.001mm	Without SPC output, Ratchet Stop	
293-243	75-100mm	0.001mm	±.002mm	Without SPC output, Ratchet Stop	
293-244	0-25mm	0.001mm	±.001mm	Without SPC output, Ratchet-Friction Thimble	
293-245	25-50mm	0.001mm	±.001mm	Without SPC output, Friction Thimble	
293-246	50-75mm	0.001mm	±.001mm	Without SPC output, Friction Thimble	
293-247	75-100mm	0.001mm	±.002mm	Without SPC output, Friction Thimble	
293-248	0-25mm	0.001mm	±.001mm	Without SPC output, Friction Thimble	

Replacement Battery: **541980** (1 pc.), **541980-10** (10 pcs./set)

## MICROMETER STANDARDS

SERIES 196:



Size Inch	Order No.	Price	Size mm	Order No.	Price
1"	1960011		25mm	1960026	
2"	1960012		50mm	1960050	
3"	1960013		75mm	1960076	
4"	1960014		100mm	1960100	
5"	1960015		125mm	1960125	
6"	1960006		150mm	1960151	
7"	1960007		175mm	1960175	
8"	1960008		200mm	1960200	
9"	1960009		225mm	1960225	
10"	1960010		250mm	1960250	
11"	1960111		275mm	1960275	

**Mitutoyo & Starrett**

**STANDARDS** available.  
See our website  
or inquire.



**INTERCHANGEABLE ANVIL  
OUTSIDE MICROMETERS**

SERIES 203:

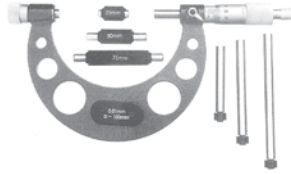

- Ratchet stop and lock nut
- High accuracy interchangeable anvils
- Carbide measuring faces
- Laser engraved graduations
- Enamel frame
- With standards in a fitted case

Range	Grad	Order No.	Price
0-6"	.001"	9030006	
6-12"	.001"	2030612	

**INTERCHANGEABLE ANVIL  
OUTSIDE MICROMETERS**

OVER 12" / 300MM LONG RANGE MODEL  
SERIES 203:

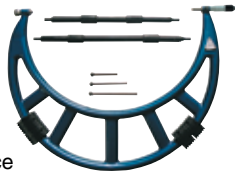

FEATURES: Pipe Construction

- Pipe combined steel frame provides lightness plus extreme rigidity for perfect balance
- Carbide measuring faces
- With standards in a fitted case
- Rapid stop and lock nut

Range	Graduation	Order No.	Price
12-16"	.001"	201216	
16-20"	.001"	9201620	
20-24"	.001"	202024	

**DIGITAL ELECTRONIC  
INTERCHANGEABLE ANVIL  
MICROMETERS**

SERIES 725:



FEATURES

- Friction Thimble
- With 5 key deluxe micrometer head
- Carbide Measuring Faces
- With Standards
- Fitted Case

Range	Graduation	Order No.	Price
0-6"/0-150mm	0.00005"/0.001mm	7256006	
6-12"/150-300mm	0.00005"/0.001mm	7256612	

**7 - PC. PRECISION  
MICROMETER  
ATTACHMENT KIT**

SERIES 197:



Anvil Type	Specifications
Disc	.500
Ball	.200
Spline	.100
Super Spline	.050
Comparator	.040 Face x 30°
Blade	.030
Knife	.020 Face x 30°

All anvils are held on with its own individual boot. Hardened and ground. Finest quality steel. Highest quality surface finish. Each anvil hand inspected. Plastic case. Micrometer not included.

Order No.	5250007
Price	

**WIDE RANGE  
OUTSIDE MICROMETERS**

MIT SERIES 104:  
WITH INTERCHANGEABLE ANVILS

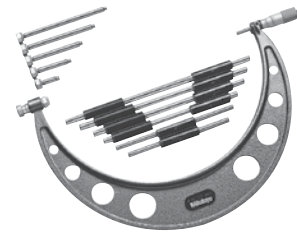

Furnished anvils are quickly interchanged, and are etched with length. Adjustable stopper on the anvil permits calibration of the overall dimension at the anvil. The .315" (8mm) diameter anvil is microlapped but not carbide tipped. The spindle diameter is .250" (up to 12") and .315" (over 12"). The spindles are carbide tipped and microlapped for lasting accuracy. Appropriate standards supplied.

Resolution .001"

Remarks	Range	Order No.	Price
Six Anvils	0-6"	104137	
	6-12	104138	
	12-18	104201	
	18-24	104202	
	24-30	104203	
	30-36	104204	
Four Anvils	36-42	104205	
	12-16	104152	
	16-20	104153	
	20-24	104154	
	24-28	104155	
	28-32	104156	
	32-36	104157	
	36-40	104158	

Resolution 0.01mm

Remarks	Range (mm)	Order No.	Price
Four Anvils	300-400	104142	
	400-500	104143	
	500-600	104144	
	600-700	104145	
Six Anvils	0-150	104135	
	150-300	104136	

**MICROMETER BALL ATTACHMENT  
SERIES 197:**

- Measures curved surfaces
- Hardened chrome ball
- Reinforced band
- Precision molded neoprene
- Ball Diameter .200"
- Fits all Micrometers up to 12"



Order No.	5250001	Price	
-----------	---------	-------	--

PRECISION TOOLS

## ELECTRONIC DIGITAL INTERCHANGEABLE ANVIL MICROMETERS (WITH OUTPUT)

STARRETT SERIES: 714:



Each micrometer is equipped with a series of easily interchangeable anvils, thus providing the full range in steps of one inch with a single micrometer. Suitable wrenches are furnished to make necessary adjustments. The larger sizes have .300" (7.6mm) anvil and spindle diameters for ease of use on larger work.

### READABILITY FEATURES

- Large, right-sized, high-contrast LCD digital readout is easy to read and reduces errors
- Conventional graduations also standard
- Attractive no-glare black wrinkle finish on the frame
- Starrett no-glare satin chrome finish on thimble and sleeve

### ACCURACY AND LONG-LIFE FEATURES

- Starrett designed electronic microprocessor
- One battery for dependable power and over one year's normal usage
- Automatic OFF after 30 minutes of nonuse

### FULL-FUNCTION ACTION FEATURES

- Easiest keyboard control by use of the new SHIFT button
- Instant inch/millimeter conversion
- Measurement HOLD button
- Ability to zero tool at any position
- Ability to retain and return to the true zero reading of the micrometer
- PRESET button to install any reading at any position
- Ability to install minimum and maximum limits
- Output data to Starrett SPC Plus hardware and software and to IBM PCs
- Includes protective case and all standards

### With Standard Inch Graduations on shell and thimble.

Range	Resolution	Catalog No.	EDP No.	Price
0-4"/ 0-100mm	.00005"/0.001mm	714AAFLZ	64427	
2-6"/ 50-150mm		714AFLZ	64428	
6-9"/ 150-225mm		714BFLZ	64429	
6-12"/ 150-300mm		714GFLZ	64430	
9-12"/ 250-300mm	.0001"/0.001mm	714CFLZ	64431	
12-16"/300-400mm		714DFLZ	64432	
16-20"/400-500mm		714EFLZ	64433	
20-24"/500-600mm		714JFLZ	64434	

### With Standard Millimeter Graduations on shell and thimble.

Range (mm)	Resolution	Catalog No.	EDP No.	Price
0-100mm/0-4"	0.001mm/.00005"	714MEAFLZ	66108	
50-150mm/2-6"		714MEAFLZ	66109	
150-300mm/6-12"		714MEGFLZ	66111	
300-400mm/12-16"	0.001mm/.0001"	714MEDFLZ	66112	
400-500mm/16-20"		714MEEFLZ	66113	
500-600mm/20-24"		714MEJFLZ	66110	

### Accessories/Parts

Part No.	EDP No.	Description	Price
PT61768	66454	Adapter from PT22938 cable to IBM-PC(RS232C)	
PT22938	64059	Shielded cable to 761/772 Series Starrett Modules, 768 Remote Display & No. PT61768 Adapter	
PT61120	65446	One 3-volt Battery No. CR2450	
PT61963	66636	Computer Interface Cable Complete to IBM-PC (RS232C)	

Starrett



## DIGIMATIC WIDE RANGE OUTSIDE MICROMETERS WITH INTERCHANGEABLE ANVILS

Mitutoyo

MIT SERIES 340:

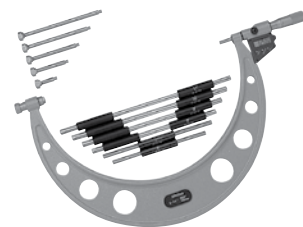

### FEATURES

- Wide measuring range with interchangeable anvils.
- Carbide-tipped spindle.
- The 340 series can be linked to the SPC system.
- Provided with Ratchet Stop for constant force.

### ACCURACY

- Flatness: within .000024" /0.6µm for up to 12"/300mm within .00004"/1µm for up to 40"/1000mm
- Parallelism: .00008"
- Measuring Accuracy: ± .0002"

### DIGIMATIC FUNCTIONS

#### Models 340-751 & 752

- Inch/mm • Preset • Zero/ABS • Data Send/Hold

#### Models 340-713, 714, 715 & 716

- Hold • Inch/mm • On/Off • Preset • Zero/ABS • Data Send

Order No.	Range	LCD Resolution	Remarks	Price
340-351	0-6"/ 0-152.4mm	.00005" /0.0001mm	with 6 Anvils & 5 Standards	
340-352	6-12"/ 152.4-304.8mm	.0005" /0.001mm	with 6 Anvils & 6 Standards	
340-713	12-18"/ 304.8-457.2mm	.0001 /0.001mm	with 6 Anvils & 6 Standards	
340-714	18-24"/ 457.2-609.6	.0001 /0.001mm	with 6 Anvils & 6 Standards	
340-715	24-30"/ 609.6-762.0mm	.0001 /0.001mm	with 6 Anvils & 6 Standards	
340-716	30-36"/ 762.0-914.4	.0001 /0.001	with 6 Anvils & 6 Standards	

For SPC output order connecting cable 937387(1m) or 965013(2m). Replacement Battery: 541980 (1pc), 541980-10 (10pcs/SET).

## MICROMETER STAND SERIES 197:

MEGA Superior Import

- Designed to allow bench-top use with hand micrometers or other gages which have frame area sufficient to grab onto.
- For 0-4"/100mm micrometers.
- Adjustable to any position and angle
- Attractive finish.

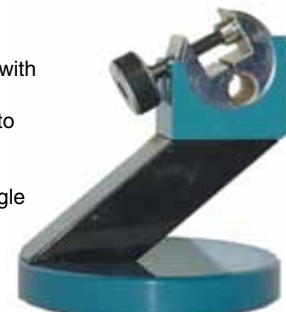

Order No. 5252000

Price:

**MUL-T-ANVIL MICROMETERS**  
STARRETT SERIES 220:



- With round and flat anvils and carbide faced spindle
- Quick-reading figures .001" or 0.01mm
- Handles wide variety of measurements which are impossible to obtain with conventional micrometers.
- Balanced frame and thimble design insure easy handling.
- Anvils are quickly interchanged by single lock screw adjustment.
- Accurate to  $\pm .0002"$  or  $\pm 0.004$ mm
- Design provides precise and easy readability.
- Ratchet Stop, Lock Nut

Catalog No.	Range	EDP No.	Price
220XRL-1	0-1"	66430	
220XRL-2	1-2"	66432	
220MXRL-25	0-25mm	65050	
220MXRL-50	25-50mm	66434	

**DIGITAL ELECTRONIC MULTI-ANVIL MICROMETERS**  
SERIES 725:



- 5 key Deluxe Model micrometer head
- Friction thimble for exact repetitive readings.
- Chrome-Plated frame.
- Carbide-tipped spindle.
- Interchangeable anvils permit quick accurate measurement of tubing, cylindrical walls, from a hole or slot to an edge, and many hard-to-reach locations.

Range	Graduation	Order No.	Price
0-1"/0-25mm	0.00005"/0.001mm	7254001	
1-2"/25-50mm	0.00005"/0.001mm	7254012	

**UNI-MIKE**

MIT SERIES 117, 317:



**INTERCHANGEABLE ANVIL TYPE**

**DIGIMATIC UNI-MIKE**

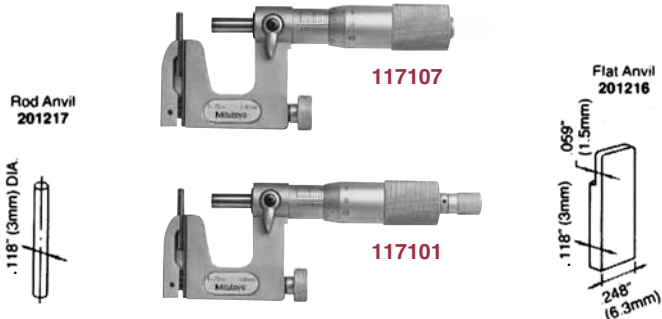

- Measures hard-to-reach locations, such as from a hole or slot to an edge, small tube wall thickness, shoulder to an edge, etc.
- Carbide tipped spindle face. Graduation .0001" or 0.01mm.
- Appropriate standards. Fitted case.

The **MITUTOYO** Uni-Mike has a vise-like special frame, which is designed to hold interchangeable anvils. Two anvils-Flat Anvil (No. 201216) and Rod Anvil (No. 201217) are supplied with Uni-Mike. Three other anvils are available to facilitate special measurements.

Among the supplied anvils, the Rod Anvil with its .118" diameter is useful in checking small tube thicknesses or checking the distance between a drilled hole to the edge of the workpiece. The Flat Anvil is .059" in thickness, and is used to measure shoulders, lands, fins, etc., as well as regular outside dimensions.



The 317 Series provides digital readout to .00005"/0.001mm and can be linked to the SPC system. Digimatic functions same as the Digimatic Outside Micrometer **MITUTOYO** Series 293 in the beginning pages of this section.

Range	Order No.	Price	Remarks
0-1"/0-25.4mm	317-351		Friction Thimble
1-2"/25.4-50.8mm	317-352		Friction Thimble

For SPC output order connecting cable **937387** (1m) or **965013** (2m).  
Replacement Battery: **541980** (1 pc), **541980-10** (10 pcs/SET)

Range	Order No.	Price	Remarks
0-1"	117107		Friction Thimble
1-2"	117108		Friction Thimble
0-25mm	117101		Ratchet Stop
25-50mm	117102		Ratchet Stop



While we show the most popular **Mitutoyo** items, we can supply their entire range of products; please inquire.

## ELECTRONIC DIGITAL MULTI-ANVIL MICROMETERS (0 – 1" and 0 – 25mm)

STARRETT SERIES 790:



Interchangeable anvil micrometer permits quick, accurate measurements of tubing, cylindrical walls, from a hole or slot to an edge, and in many other hard-to-reach places. Two anvils are furnished with the tool – a round anvil, approximately .120" diameter; and a flat anvil, approximately .125" diameter and .060" in thickness. Anvils are rigidly held in a vise-type frame that allows for quick changes by a single lock screw.

- Output capability to Starrett SPC Plus hardware and software and to IBM compatible PCs
- High-contrast LCD readout with large numbers
- Auto shutdown after 30 minutes of idle time
- One-year working battery life
- Error and flashing out-of-tolerance displays
- Zero setting at any location
- Instant inch/mm conversion
- High-low limit settings
- Zero setting at any spindle location
- Limits mode for entering product specifications
- Non-glare satin chrome finish on thimble and sleeve
- Friction thimble
- Ring-type lock nut
- Rigid frame construction and balanced feel

### With standard inch graduations on shell and thimble

Range	Catalog Resolution	EDP No.	No.	Price
0-1"/0-25mm .001mm	.00005"/ .001mm	790AFL-1	64048	

### With standard millimeter graduations on shell and thimble

0-25mm/0-1"	.001mm/ .00005"	790MEAFL-25	66071	
-------------	--------------------	-------------	-------	--

### Cable Information

Part No.	EDP No.	Price	Description
61768	66454		Adapter and disc from No. PT22938 cable to IBM-PC (RS232C)
PT 22938	64059		Shielded cable to Nos. 761/772 Series Starrett modules, No. 768 remote display and No. PT61768 Adapter
PT61120	65446		One 3-volt battery No. CR2450
PT61963	66636		Computer Interface Cable complete to IBM-PC (RS232C)



While we show the most popular **Starrett** items, we can supply their entire range of products; please inquire.



## V-ANVIL MICROMETERS STARRETT SERIES 483, 485:



For checking out-of-roundness in centerless grinding and other machining operations; also for measuring odd-fluted taps, milling cutters, reamers. Direct reading. Carbide facings on spindle and anvils. Anvils match index of cutter teeth. Hardened, ground-from-the-solid spindle threads for accurate reading. No glare satin chrome finish. Quick-reading – every thousandth numbered.

### With ratchet stop and lock nut.

Range	Grad.	No. of Flutes Will Measure	Catalog No.	EDP No.	Price
.093 – 1"	.0001"	3	T483XRL-1	52491	
1 – 2"	.0001	3	T483XRL-2	52494	
.078 – 1"	.0001	5	T485XRL	52497	
2-25mm	.01mm	3	483MXRL-25	56046	
2-25mm	.01mm	5	485MXRL	56047	

Fitted cases available, please inquire.

## SHEET METAL MICROMETERS STARRETT SERIES 222:



These micrometers reach over the edge of sheet metal and take measurements away from the edge toward the center. Also for other gaging jobs where a deep throat micrometer is needed. Rounded anvil on 1"/25mm size gives a point contact for more accurate gaging; flat anvil also available. 1/2"/ 13mm micrometers have Satin Chrome Finish; 1" micrometer frames have black wrinkle finish.

Grad	Description	Catalog No.	EDP No.	Price
2" Throat Depth; 0 - 1/2" range				
.001"	Ratchet stop, lock nut	222XRL-1/2	50757	
6" Throat Depth; 0 - 1" range				
.001	Ratchet stop, no lock nut	222AXR-1	50762	
50mm Throat Depth; 0 - 13 mm range				
0.01mm	Ratchet stop lock nut	222MRL-13	50758	
150mm Throat Depth; 0 - 25 mm range				
0.01mm	Ratchet stop no lock nut	222MAXR-25	66435	

**BLADE TYPE MICROMETERS**

STARRETT  
SERIES 486:



Starrett



Blade type anvil and spindle for measuring circular form tools, diameter and depth of narrow grooves, slots, keyways, recesses, shallow depths, between lands and fins. Non-rotating spindle prevents blade turning. Blades .030" thick, measure depths to 5/16". Speeder on end of thimble for faster settings and measurements. Specially forged, black enameled frame with satin chrome finish on sleeve and thimble.

Range	Graduation	Catalog No.	EDP No.	Price
0 - 1"	.001"	486P-1	52499	
1 - 2	.001	486P-2	52501	
2 - 3	.001	486P-3	52503	
3 - 4	.001	486P-4	52505	
4 - 5	.001	486P-5	52507	
5 - 6	.001	486P-6	52509	
0-25mm	0.01mm	486MP-25	64257	
25-50mm	0.01mm	486MP-50	64258	
50-75mm	0.01mm	486MP-75	64259	
75-100mm	0.01mm	486MP-100	64260	
100-125mm	0.01mm	486MP-125	64261	
125-150mm	0.01mm	486MP-150	64262	

Sent without case unless otherwise ordered. Attractive, protective case available by ordering No. 436ZZ and one size larger than the micrometer. Example: For No. 486P-2, order 436ZZ-3.

**DIGITAL ELECTRONIC BLADE MICROMETERS**

SERIES 725:

MEJA  
Superior Import

- Friction thimble
- Chrome-plated frame.
- 5 key deluxe micrometer head.



Range	Graduation	Order No.	Price
0-1"/0-25mm	0.00005"/0.001mm	7257001	

**TUBE MICROMETER**

SERIES 203:

MEJA  
Superior Import

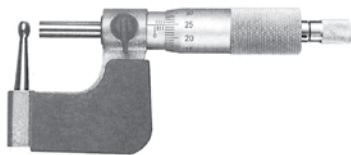

**FEATURES**

- Ratchet stop
- Carbide-tipped spindle
- Laser engraved graduations
- Enamel frame

Range	Graduation	Order No.	Price
0-1"	.0001"	1462020	

**BLADE MICROMETERS**

MIT SERIES 122:  
NON-ROTATING SPINDLE

Mitutoyo



- For measurements of narrow grooves, key-ways and other hard to reach dimensions.
- Blade dimensions - .030" wide x .250" long.
- Decimal equivalents marked on frame (1" models 122-125).
- Hammertone green frame finish on 2", 3" and 4" models.
- Quick zero adjustment on the sleeve.
- Appropriate standards supplied.

Graduation .0001" or 0.01mm

Range	Order No.	Price
0-1"	122125	
1-2"	122126	
2-3"	122127	
3-4"	122128	
0-25 mm	122101	
25-50 mm	122102	
50-75 mm	122103	
75-100 mm	122104	

**DIGIMATIC BLADE MICROMETERS**

MIT SERIES 422:

NON-ROTATING SPINDLE

Mitutoyo



422311



422312

(Functions same as Mitutoyo Series 293 Outside Micrometers shown at the beginning of this section.)

INCH/METRIC

Resolution .00005"/0.001mm

Range	Order No.	Price
0-1" 0-25.4mm	422330	
1-2" 25.4-50.8mm	422331	
2-3" 50.8-76.2mm	422332	
3-4" 76.2-101.6mm	422333	

For SPC output order connecting cable 937387 (1m) or 965013 (2m).

Replacement Battery: 541980 (1 pc), 541980-10 (10 pc/set)

METRIC ONLY

Resolution 0.001mm

Range	Order No.	Price
0-25mm	422230	
25-50mm	422231	
50-75mm	422232	
75-100mm	422233	

## DISC MICROMETERS (GEAR TOOTH)

SERIES 203:

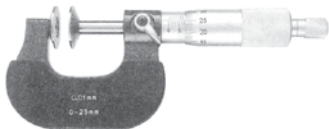

### SPECIAL FEATURES :

- Anvil and spindle hardened and precision ground — micro-lap finish on measuring faces.
- Quick and easy zero adjustment.
- Every thousandth is numbered micro-fine for easy reading.
- Deluxe heat-insulator on satin chrome finished forged steel frame, tapered for hard to get at places.
- Disc type anvil and spindle - simplifies measuring thicknesses of difficult, closely spaced sections, ribs, keys, fins, cutting edges on forming tools, chordal thickness of gear teeth, etc.
- Positive locking clamp.
- Large diameter, disc will enter inaccessible places such as narrow grooves, slots and recesses over .030" width.

Range	Graduation	Order No.	Price
0-1"	.001"	1475901	
1-2"	.001"	1475902	
0-25 mm	.01mm	1475903	
25-50 mm	.01mm	1475904	

## DISC TYPE MICROMETERS

STARRETT SERIES 256:



**Starrett**



Anvil and spindle discs – 1/2" (12.7mm) diameter, tapering to .015" (0.4mm) edge thickness – enter narrow grooves, slots and recesses to measure work sections such as ribs, lands, fins; cutting edges on forming tools, and chordal thickness of gear teeth. 0 -1 inch /0-25mm size is also useful for measuring the thickness of paper, cardboard, rubber and sheet plastic. Satin chrome finish on reading surfaces. Rotating spindle except where noted.

### Graduation .001" or 0.01mm

Range	Description	Catalog No.	EDP No.	Price
0-1"	With ratchet stop, lock nut	256RL-1	51236	
1-2"	With ratchet stop, lock nut	256RL-2	55940	
2-3"	With ratchet stop, lock nut	256RL-3	55941	
0-1"	Non - Rotating Spindle	256PN-1	56469	
0-25mm	With ratchet stop, lock nut	256MRL-25	51238	
25-50mm	With ratchet stop, lock nut	256MRL-50	55942	
50-75mm	With ratchet stop, Locknut	256MRL-75	55943	
0-25mm	Non-Rotating Spindle	256MPN-25	56470	

1" and 25mm sent in fitted case. Deluxe case available by ordering No. 910. 2" and 50mm and above are packed one in a box without case. Deluxe cases available by ordering No. 912 for the 2" and 50mm sizes and No. 256ZZ-3 for the 3" and 75 mm sizes.

**378**

## DISC MICROMETERS

MIT SERIES 123, 223:

ROTATING SPINDLE TYPE

**Mitutoyo**



123125

The thin measuring discs, with .030" edge thickness, enter narrow grooves, slots and recesses, to take measurements on work sections such as ribs, lands, fins, cutting edges on form tools and chordal thickness on gear teeth.

- Measuring discs are hardened, ground and micro-lapped for greater accuracy.
- Extra-large disc, .787" in diameter, with .030" edge thickness to enter narrow recesses.
- With heat-insulating grip cover on frame.
- Appropriate standards supplied.
- Supplied with fitted carrying case.

### Graduation .001" or 0.01mm

Range	Order No.	Price
0-1"	123125	
1-2"	123126	
2-3"	123127	
3-4"	123128	
0-1"	223125*	
0-25mm	123101	
25-50mm	123102	
50-75mm	123103	
75-100mm	123104	
0-25mm	223101*	

\* With Digital Counter



See next page for **Mitutoyo**  
Digimatic Disc Micrometers

## DIGITAL ELECTRONIC DISC MICROMETER

SERIES 725:

**MEGA**  
Superior Import



- Friction thimble.
- Chrome-plated frame.
- With 5 key deluxe model micrometer head.

Range	Graduation	Order No.	Price
0-1"/0-25mm	.00005"/.001mm	7253001	



## ELECTRONIC DIGITAL DISC TYPE MICROMETER

STARRETT  
SERIES 756:



For applications where the thickness of lands or sections bounded by grooves or slots are as narrow as .015". The thin, tapered anvil and spindle discs measure 1/2" (12.7mm) in diameter tapering to .015" (0.4mm) edge thickness permitting entrance to such spaces. In addition, the large anvil is also suitable for measuring sheet materials.

- Output capability to Starrett SPC Plus hardware and software and to IBM-compatible PCs
- High-contrast LCD readout with large numbers
- Auto shutdown after 30 minutes of idle time
- One-year working battery life
- Error and flashing out-of-tolerance displays
- Zero setting at any location
- Instant inch/mm conversion
- High-low limit settings
- Zero setting at any spindle location
- Limits mode for entering product specifications
- Non-glare satin chrome finish on thimble and sleeve
- Friction thimble
- Ring-type lock nut
- Rigid frame construction and balanced feel
- Resolution: -.00005" and 0.001mm

With standard Inch graduation on shell and thimble.

Catalog No.	EDP No.	Description	Price
756FL-1	64042	0-1" / 0-25mm Range, without case	

With standard mm graduations on shell and thimble.

Catalog. No	EDP No.	Description	Price
756MEFL-25	66134	0- 25mm/0-1" Range, without case	

### Cable Information and Case

Catalog No.	EDP No.	Description	Price
PT61768	66454	Adapter from No.PT22938 to IBM-PC (RS232C)	
PT22938	64059	Shielded cable to Nos. 761/772 Series Starrett Modules, No. 768 Remote Display and No. PT61768 Adapter	
PT61120	65446	One 3-Volt Battery No. CR2450	
949	63874	Case	
PT61963	66636	Computer Interface Cable complete to IBM-PC (RS232C)	

## DIGIMATIC DISC MICROMETERS

MIT SERIES 323:

ROTATING SPINDLE TYPE



Mitutoyo

(Functions same as Mitutoyo Series 293 Outside Micrometers shown at the beginning of this section.)

### DIGIMATIC DISC MICROMETERS

Range	Resolution	Order No.	Price
<b>Inch/Metric</b>			
0-1"/0-25.4mm	.00005"/0.001mm	323350	
1-2"/25.4-50.8 mm	.00005"/0.001mm	323351	
2-3"/50.8-76.2 mm	.00005"/0.001mm	323352	
3-4"/76.2-101.6 mm	.00005"/0.001mm	323353	
<b>Metric</b>			
0-25 mm	0.001 mm	323250	
25-50 mm	0.001 mm	323251	

For SPC output order connecting cable  
937387 (1m) or 965013 (2m).

Replacement Battery:  
541980 (1 pc), 541980-10 (10 pc/set)

## POINT MICROMETERS

MIT SERIES 112:

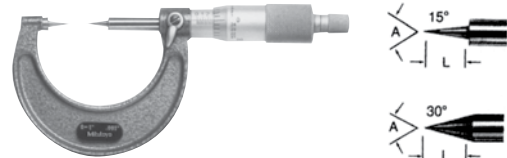

Mitutoyo

For measurements of small grooves, keyways and other hard-to-reach dimensions. The measuring points have approximately .012" radius, and are available with or without carbide tips.

Graduation .001" or 0.01mm

Range	Order No.	(A)	(L)	Price
0-1"	112177*	15°	.394"	
0-1"	112225*	30°	.430"	
1-2"	112178*	15°	.394"	
1-2"	112226*	30°	.430"	
0-1"	112189**	15°	.394"	
0-1"	112237**	30°	.430"	
1-2"	112190**	15°	.394"	
1-2"	112238**	30°	.430"	
0-25mm	112153*	15°	10mm	
0-25mm	112201*	30°	11mm	

\* Without Carbide Measuring Points.

\*\* With Carbide Measuring Points.



Mitutoyo Digimatic Point Micrometers available; please inquire.

## INDICATING MICROMETERS

SERIES 209:



### SPECIAL FEATURES :

Pinion and Gear are hardened. The anvil withdraws .079" to insert or extract the object being measured. Every thousandth is numbered for easy setting. All parts subject to wear fully hardened. Retracting button convenient to operator's thumb. Uniform pressure is exerted at all times. Tolerance hands can be set as desired. Wider graduation for easy reading. Quick and easy zero adjustment. Tool operates as a go/no-go gage and as a limited run, sensitive, indicating micrometer. Hammertone gray baked enamel finished frame. After setting the micrometer, spindle can be locked. Indicating accuracy to .00004" or .001mm. Minimum dial reading .0001" or .002mm. Carbide faces. Jeweled bearings. Spindle diameter .315" (8mm). Anvil and spindle hardened and precision ground - with micro-lap finish on measuring faces. Spindle clamp ring. Indicating range .001" or .02mm. Includes fitted case.



## INDICATOR MICROMETERS

SERIES 203:



- Carbide faces
- Chrome-plated frame
- Premium quality
- Can be used as Go/No Go gage

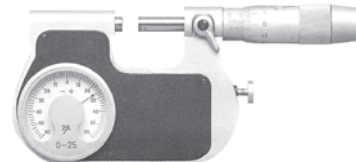

Range	Graduation	Order No.	Price
<b>INCH</b>			
0-1"	.00005"	2030005	
1-2"	.00005"	2030009	
<b>METRIC</b>			
0-25mm	.001mm	2030007	

### INCH Grad. .0001"

Range	Order No.	Price
0-1"	5101001	
1-2"	5101002	

### METRIC Grad. .01mm

Range	Order No.	Price
0-25mm	2245101	

Limited Quantity Available

## SCREW THREAD COMPARATOR MICROMETERS

STARRETT SERIES 210:



Designed for comparing threads, measuring in grooves, recesses and other applications. (Will not measure pitch diameter.) Conical anvil and spindle faces with 1/64"(0.4mm) flats on points. Black enamel frame. Satin chrome finish on sleeve and thimble. Hardened threads ground from the solid. Fitted Case. No Ratchet or Lock Nut

Range	Graduation	Catalog No.	EDP No.	Price
0 - 7/8"	.001"	210AP	50731	
0 - 22mm	0.01mm	210MAP	64334	

## INDICATING MICROMETERS

MIT SERIES 510:



- Tool operates as a Go/No-Go Gage and as a limited run, sensitive, indicating micrometer.
- Indicating accuracy to .00008".
- Minimum dial reading .0001" or .001mm.
- Carbide faces.
- Jeweled bearings.
- Vernier scale on barrel.
- Spindle diameter .315" (8mm).
- Anvil and spindle hardened and precision ground - with micro-lap finish on measuring faces.
- Spindle clamping ring.
- Clear graduations on satin-chrome finish.
- Every thousandth is numbered for easy setting.
- All parts subject to wear fully hardened.
- Retracting button convenient to operator's thumb.
- Tolerance hands can be set as desired.
- Wider graduation for easy reading.
- Quick and easy zero adjustment.
- Complete with fitted carrying case.



## SCREW THREAD MICROMETERS

SERIES 203:

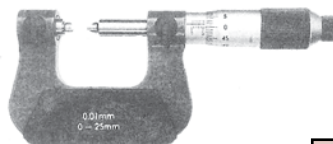

- Ratchet Stop
- Laser engraved graduations.
- Enamel frame.
- V-Anvils included: 64-48, 44-34, 28-20, 18-12, 11-7, 6-4.5 TPI
- Graduation .001" or .01mm

Range	Order No.	Price	Grad. of Head	Range of Indicator	Depth of Frame
<b>INCH</b>					
0-1	510131		.0001	±.001	.7"
1-2	510132		.0001	±.001 with standard	1.06
2-3	510133		.0001	±.001 with standard	1.54
3-4	510134		.0001	±.001 with standard	2.15
<b>METRIC</b>					
0-25	510121		.01mm	±0.02mm	18mm
25-50	510122		.01mm	±0.02mm w/ standard	27mm

Range	Order No.	Price
<b>INCH</b>		
0-1"	2030001	
1-2"	2030002	
2-3"	2030003	
3-4"	2030004	
<b>METRIC</b>		
0-25mm	9030025	

## SCREW THREAD MICROMETERS

MIT SERIES 126, 326:

Each anvil can be used for both metric and unified external threads. The correct pair of anvils must be selected and inserted in the hollow micrometer spindle and anvil. The micrometer anvil is fully adjustable by the knurled knob located on the anvil side of the frame. Zero set the micrometer with this knob whenever the anvil is interchanged.

### INTERCHANGEABLE V-ANVIL TYPE FOR MEASURING PITCH DIAMETER



- 60 degree V-Anvil and Conical Spindle are made of high-grade special steel, hardened and precision ground.
- Ratchet stop facilitates uniform and consistent measurements.
- Furnished complete with fitted carrying case and appropriate standards.
- Graduation .001" or 0.01mm

No Anvils			With Anvil Set		
Range	Order No	Price	Range	Order No	Price
0-1	126137		0-1	126901	
1-2	126138		1-2	126902	
2-3	126139		2-3	126903	
3-4	126140		3-4	126904	
4-5	126141		4-5	126905	
5-6	126142		5-6	126906	
0-25mm	126125				
25-50mm	126126				

### DIGIMATIC SCREW THREAD MICROMETERS



- The 326 Series provides digital readout to .00005"/0.0001mm and can be linked to the SPC system.
- Digimatic functions same as the Digimatic Outside Micrometers Series 293 at the first pages of this section.

#### Inch/Metric (No Anvils)

Range	LCD Resolution	Order No.	Price
0-1" 0-25.4mm	.00005" 0.001mm	326-351	
1-2" 25.4-50.8mm	.00005" 0.001mm	326-352	
2-3" 50.8-76.2mm	.00005" 0.001mm	326-353	
3-4" 76.2-101.6mm	.00005" 0.001mm	326-354	

For SPC output order connecting cable 937387 (1m) or 965013 (2m). Replacement Battery: 541980 (1 pc), 541980-10 (10 pcs/SET)

#### Individual 60° Anvils for Unified Screw Threads

Threads per Inch	Pitch	Order No. (Pair)	Price
64-48 Threads (M1)	.016-.019"/0.4-0.5mm	126801	
44-28 Threads (M2)	.024-.035"/0.6-0.9mm	126802	
24-14 Threads (M3)	.04-.068"/1.0-1.75mm	126803	
13-9 Threads (M4)	.079-.118"/2.0-3.0mm	126804	
8-5 Threads (M5)	.138-.196"/3.5-5.0mm	126805	
4.5-3.5 Threads (M6)	.217-.275"/5.5-7.0mm	126806	
64-3 Threads	.016-.275"/0.4-7.0mm	126800*	

\* Anvil Set

Mitutoyo

## ELECTRONIC DIGITAL SCREW THREAD COMPARATOR MICROMETER

STARRETT SERIES 760:

Starrett



Micrometer has 60 degree conical anvil and spindle faces with 1/64" (0.4mm) flats on the ends of the points. This allows measuring in small grooves, recesses, and many other applications that conventional micrometers are not suited for. (Will not measure pitch diameter).

- Output capability to Starrett SPC Plus hardware and software and to IBM compatible PCs
- High-contrast LCD readout with large numbers
- Auto shutdown after 30 minutes of idle time
- One-year working battery life
- Error and flashing out-of-tolerance displays
- Zero setting at any location
- Instant inch/mm conversion
- High-low limit settings
- Zero setting at any spindle location
- Limits mode for entering product specifications
- Non-glare satin chrome finish on thimble and sleeve
- Friction thimble
- Ring-type lock nut
- Rigid frame construction and balanced feel
- Resolution: -.00005" and 0.001mm

#### With standard Inch graduations on shell and thimble

Catalog No.	EDP No.	Description	Price
760FL	64051	0-1"/0-25mm Range without case	

#### With standard millimeter graduations on shell and thimble.

Catalog No.	EDP No.	Description	Price
760MEFL	66135	0-25mm/0-1" Range, without case	

Catalog No.	EDP No.	Description	Price
<b>Cable Information</b>			
PT61768	66454	Adapter from No. PT22938 Cable to IBM-PC (CRS232C)	
PT22938	64059	Shielded Cable to Nos. 761/772 Series Starrett Modules No. 768 Remote Display and No. PT61768 Adapter	
PT61120	65446	One 3-Volt Battery No. CR2450	
PT61963	66636	Computer Interface Cable complete to IBM-PC (RS232C)	

Case available by ordering No. 733ZZ-2

## SCREW THREAD MICROMETERS FOR MEASURING PITCH DIAMETER

STARRETT SERIES 575, 585:



For measuring V, American National, Unified and Unified J series screw threads. These micrometers have a pointed spindle and a double V-anvil, both shaped to contact the screw thread at the pitch diameter. The micrometer reading therefore gives the true pitch diameter which equals the outside diameter of the screw minus the depth of one thread. Frames are rigid, one-piece drop forged steel with no-glare satin chrome finish all over. One-piece hardened spindle with threads ground from the solid. Furnished with fixed (non-rotating) anvil, without ratchet stop or lock nut, and appropriate standards.



## INSIDE MICROMETERS SERIES 203:



- Graduations .001" or .01mm
- Caliper type jaws.
- Chrome-plated
- Carbide measuring faces.
- Ratchet stop for exact repetitive readings.
- Complete with fitted case.

Range	Order No.	Price
0.2-1.2"	2050212	
1-2"	2051020	
5-30mm	2050530	
25-50mm	2052550	

## INSIDE MICROMETER CALIPERS

STARRETT SERIES 700:



Caliper type jaws permit quick inside measurements with micrometer accuracy. Jaws are hardened and ground on a radius for accurate feel without cramping. Satin chrome finish – no glare, resists rust. Friction Thimble. Lock Screw.

Range	Grad.	Description	Catalog No.	EDP No.	Price
.200 – 1.200"	.001"	With lock screw	700A	52909	
1 – 2"	.001"	With lock screw	700B	52911	
5 - 30mm	0.01mm	With lock screw	700MA	56063	
25- 50mm	0.01mm	With lock screw	700MB	9956064	

Sent without case. Case available by ordering Catalog No. 940 (EDP No. 55359)

Capacity, Pitch Diameter	Range Threads per Inch	Grad.	Catalog No.	EDP No.	Price
0 - 1"	7 - 9	.001"	575AP	56159	
0 - 1	10 - 13	.001	575BP	56160	
0 - 1	14 - 18	.001	575CP	56161	
0 - 1	20 - 24	.001	575DP	56162	
0 - 1	28 - 30	.001	575EP	56163	
0 - 1	32 - 40	.001	575FP	56164	
1 - 2	4-1/2 - 6	.001	585AP	56165	
1 - 2	7 - 9	.001	585BP	56166	
1 - 2	10 - 13	.001	585CP	56167	
1 - 2	14 - 18	.001	585DP	56168	
1 - 2	20 - 24	.001	585EP	56169	
1 - 2	28 - 30	.001	585FP	56170	

Capacity, Pitch Diameter	Range Threads Per Inch	Grad.	Catalog No.	EDP No.	Price
0 - 25	3 - 4	0.01mm	575MAP	9956321	
0 - 25	2 - 2.5	0.01mm	575MBP	56322	
0 - 25	1.25 - 1.75	0.01mm	575MCP	56323	
0 - 25	0.75 - 1	0.01mm	575MDP	56324	
0 - 25	0.5 - 0.7	0.01mm	575MEP	56325	
0 - 25	0.35 - 0.45	0.01mm	575MFP	56326	
25 - 50	4.5 - 6	0.01mm	585MAP	56327	
25 - 50	3 - 4	0.01mm	585MBP	56328	
25 - 50	2 - 2.5	0.01mm	585MCP	56329	
25 - 50	1.25 - 1.75	0.01mm	585MDP	56330	

No. 575 sent in fitted case. No. 585 packed one in a box without case - attractive, protective cases available by ordering No. 910 for the Catalog No. 575 series and No. 912 for the Catalog No. 585 series

## GROOVE MICROMETERS

STARRETT SERIES 260:



Widths of either internal or external grooves and lands can be quickly measured. Graduated in .001" (0.01mm) and has a reach of 1-5/8" (41mm) maximum hole depth. Each measuring disc is 9/32" (7mm) O.D., .025" (0.63mm) thick and hardened, ground and lapped. With ratchet stop. Satin chrome finish with quick-reading, staggered graduations. Furnished with case.

Range Groove Widths	Range Land Widths	Grad.	Catalog No.	EDP No.	Price
.050 – 1.050"	0 – 1.000"	.001"	260Z	67987	
1.27-26.27mm	0-25mm	0.01mm	260MZ	67988	

## DIGITAL ELECTRONIC INSIDE MICROMETERS

SERIES 725:



- Graduation .00005"/.001mm
- With 5 key deluxe model micrometer head

Range	Order No.	Price
0.2-1.2"/5-30mm	7250212	
1-2"/25-50mm	7251021	

## SOLID ROD INSIDE MICROMETERS

STARRETT SERIES 124:

- For Measuring inside diameters of cylinders and rings, parallel surfaces etc.
- Quick reading figures - every thousandth numbered.
- Each rod is solid, marked with length, and assembled on one side of micrometer head.
- Rods have individual length adjustment.
- Heads and rods have hardened and ground anvils.
- Non-glare satin chrome thimble and sleeve.
- Furnished in case with rods, tools, and adjusting wrenches



Graduation .001" or .01mm

Range	No. of Meas. Rods	Catalog No.	EDP No.	Price
2-8"	6	124AZ	50542	
2-12"	10	124BZ	50546	
50-200mm	6	124MAZ	56141	
50-300mm	10	124MBZ	56142	

## INSIDE MICROMETERS

MIT SERIES 141:

### INTERCHANGEABLE ROD TYPE

The 141 Series Inside Micrometers are probably the most frequently used inside measuring instruments because of their wide range and simplicity in measuring operation.

To provide point contact, all contact points are made spherical and hardened for extra long tool life. The overall accuracy is .0004" up to 12" , .001" thereafter to 40".

- Each interchangeable rod is marked with its measuring range.
- Both micrometer head and furnished rods are satin-chrome finished throughout.
- Positive locking clamp attached on No. 141101 and 141102. No lock on the larger sizes.
- Supplied with fitted carrying case.

For closer tolerance work it is recommended that the micrometer with a rod inserted be calibrated with a known size such as a ring gage. The setting ring for "Holtest" would be an ideal choice.

Graduation .001"

Range (Inches)	Order No.	Travel of Micrometer Head	Price	No. of Rods	Spacing Collar
1-2	141102	.250		2	.250
2-8	141208	.500		6	.500
2-12	141233	.500		10	.500
4-20	141121	1		3	1,2
4-40	141122	1		8	1,2

Graduation .01mm

Range (mm)	Order No.	Travel of Micrometer Head	Price	No. of Rods	Spacing Collar
25-50	141101	7.0mm		2	6.0mm
50-200	141205	13.0mm		6	12.0mm
50-300	141206	13.0mm		10	12.0mm
200-500	141117	25.0mm		3	25,50mm
200-1000	141118	25.0mm		8	25,50mm

## TUBULAR INSIDE MICROMETERS

STARRETT SERIES 823:

Available in nine sizes which will measure down to 1-1/2" or 40mm minimum and with extension rods up to 40" or 1000mm maximum inclusive. Graduation of .001" or 0.01mm. The extension rods are made of steel tubing, centerless ground. Rods are approximately 3/8" (9.5mm) diameter and have thermal insulators. By removing the hardened and ground anvil ends (end caps) of the micrometer head, the rods may be attached to either or both ends of the micrometer as preferred. Each rod is marked with the length and may be individually adjusted for wear by the hardened and ground anvil at the end. Furnished in case.



Range	Movement of Screw	Description	Catalog No.	EDP No.	Price
<b>Graduation .001"</b>					
1-1/2 - 8"	1/2"	With 5 rods and handle	823AZ	53050	
1-1/2 - 12	1/2"	With 8 rods and handle	823BZ	53052	
4 - 24	1	With 7 rods	823CZ	53054	
4 - 32	1	With 8 rods	823DZ	53055	
4 - 40	1	With 10 rods	823EZ	53056	
1-1/2 - 32	1/2 & 1 (2heads)	With 10 rods and handle	823FZ	53058	
<b>Graduation 0.01mm</b>					
40-200mm	13mm	With 6 rods and handle	823MAZ	53051	
40-300mm	13mm	With 6 rods and handle	823MBZ	53053	
100-1000mm	25mm	With 10 rods	823MEZ	53057	

## INSIDE MICROMETERS

MIT SERIES 137:

### EXTENSION TYPE

Wide range of ID measurements by combining extension rods with micrometer head.

Series 137 features Rods with internal standards as compared to the tubular construction Series 139 and 140.

Micrometer Head Stroke : .5" or 13.0mm

MICROMETER SETS Graduation .001"

Range	Order No.	Price	No. Rods
2-12	137212		5
2-40	137214		8

MICROMETER SETS Graduation .01mm

Range	Order No.	Price	No. Rods
50-300mm	137202		5
50-1000mm	137204		8
50-500mm	137208		6



Digimatic Inside Micrometers with inch/metric graduations available; please inquire.

## TUBULAR INSIDE MICROMETERS

MIT SERIES 139, 140:

HEAVY DUTY TYPE, MIT SERIES 139:

- Diameter of Extension Tubes: .669".
- Travel of Micrometer Head: 1".
- Graduation .001"

EXTRA-HEAVY DUTY TYPE, MIT SERIES 140:

- Diameter of Extension Tubes: 1.26".
- Travel of Micrometer Head: 2".
- Graduation .001"

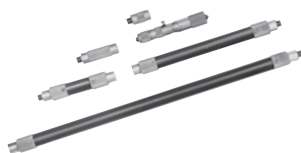

## TAPER (BORE) GAGE

SERIES 247:



- Handy gage for measuring cylindrical bores, bearing work and for gaging slots.
- Made from polished stainless steel
- Clearly etched graduations for precise measurement. (Inch one side, mm's on the other)

Order No.	Range		Price
	Inch	mm	
2470115	1/32-5/8"	1 to 15	

## DIAL BORE GAGE SETS

SERIES 567:



For close tolerance I.D. measurements. Sets include dial indicator with protective cover, anvils, and spacers, in a fitted case.

INCH Graduation .0005"

Range	Bore Depth	Order No.	Price
.25 - .40"	1.57	5670010	
.40 - .70"	4	5670018	
.7 - 1.5"	5	5670035	
1.4 - 2.4"	6	5670060	
2.0 - 6.0"	6	5670150	

METRIC Graduation .01mm

Range	Bore Depth	Order No.	Price
6-10mm	40mm	5670610	
10-18mm	100mm	5671018	
18-35mm	125mm	5671835	
35-50mm	150mm	5673550	
50-100mm	150mm	5675010	
50-160mm	150mm	5675016	

METRIC: 38 - 308mm Range

Total Range with Extensions	Dial Indicator Graduation	Catalog No.	EDP No.	Price
Max. Bore Depth 100mm				
Max. Plunger Travel 0.76mm				
38-76.2mm	0.002mm	84MZ-161-4J	64922	
38-76.2mm	0.01mm	84MZ-181-4J	64923	
Max. Bore Depth 150mm				
Max. Plunger Travel 0.9mm				
76.2-131.75mm	0.002mm	84MZ-161-5J	64924	
76.2-131.75mm	0.01mm	84MZ-181-5J	64925	
127-206.37mm	0.002mm	84MZ-161-6J	64926	
127-206.37mm	0.01mm	84MZ-181-6J	64927	
Max. Bore Depth 175mm				
Max. Plunger Travel 0.9mm				
203.2-308mm	0.002mm	84MZ-161-75	64928	
203.2-308mm	0.01mm	84MZ-181-75	64929	

PRECISION TOOLS

## INSIDE DIAMETER MICROMETERS

### LARGE RANGE TUBULAR TYPE

SERIES 203:



- Carbide measuring faces
- Laser engraved graduations
- Thermal insulator on each rod
- Each rod marked with length
- Laser engraved grads.
- Carbide measuring faces
- Chrome-plated



Range	Graduation	Order No.	Price
2-10"	.001"	203210	
4-36"	.001"	203436	
6-55"	.001"	203655	

## DIAL BORE GAGES WITH 3-POINT CONTACT

STARRETT SERIES 84:

For inspecting bores and checking hole size. An adjusting range screw with positive locking feature and two centralizing plungers provides three-point contact for true alignment. The gaging contact and centralizing plungers are hardened tool steel, spring loaded for sensitivity and repeatability, and travel in bronze bushings. The range screw, also hardened tool steel, is inserted in a steel sleeve. Housing and knurled handle are aluminum with black finish. Furnished in case.



INCH: 1-1/2 - 12-1/8" Range

Total Range with Extensions	Dial Indicator Graduation	Catalog No.	EDP No.	Price
Max. Bore Depth 4" - Max. Plunger Travel .030"				
1-1/2 - 3"	.0001"	84Z-111-4J	56264	
1-1/2 - 3"	.0005	84Z-134-4J	56270	
Max. Bore Depth 6" - Max. Plunger Travel .035"				
3 - 5-13/16	.0001	84Z-111-5J	50386	
3 - 5-13/16	.0005	84Z-134-5J	50392	
5 - 8-1/8	.0001	84Z-111-6J	50388	
5 - 8-1/8	.0005	84Z-134-6J	50394	
Max. Bore Depth 7" - Max. Plunger Travel .035"				
8 - 12-1/8"	.0001	84Z-111-7J	50390	
8 - 12-1/8"	.0005	84Z-134-7J	50396	